

INDICATORE DI LIVELLO PFG05

Linea di prodotto: **Rotativo**

Apparecchio di costruzione robusta e di sicuro affidamento, particolarmente indicato in condizioni di lavoro gravose e ritmi continuati. Versione con filetto maschio da 2"1/2 Gas per montaggio con manicotto o flangia.

VANTAGGI

- Strumento di **FACILE INSTALLAZIONE** che non richiede alcuna taratura, manutenzione o utensile specifico per il suo montaggio.
- Grazie all'ampia scelta di eliche, tra loro tutte intercambiabili, è **ADATTABILE** alle diverse densità dei materiali da rilevare.
- Estremamente **VERSATILE** può essere montato su serbatoi, tramogge a parete o sul tetto dei silos, in posizione verticale, orizzontale od obliqua.
- **PERSONALIZZABILE** con diversi tipi di **eliche** in nylon e acciaio inox, **prolunghe** e protezioni in ferro e acciaio inox, fissaggio con flangia o manicotto.
- **ROBUSTO** ed **AFFIDABILE** con carcassa in alluminio, albero in acciaio inox su cuscinetti a sfera e collegamento elettrico tramite faston antivibrazione. Può lavorare ad una temperatura ambiente da -20 a +70°C.
- A richiesta:
 - FILTRO ANTI-CONDENSA:** aiuta a prevenire la formazione di condensa all'interno della carcassa dell'indicatore di livello.
 - 8 IMPULSI** per rotazione: consente di verificare da remoto il corretto funzionamento dell'indicatore di livello.
 - CONTROLLO TENSIONE:** per verificare da remoto la corretta alimentazione dell'indicatore di livello.
 - DOPPIO CONTATTO:** per avere un contatto pulito aggiuntivo per controllare altri automatismi dell'impianto.
 - 4 RPM:** per ridurre i tempi di intervento dello strumento.
 - BASSA TEMPERATURA:** consente l'operatività dello strumento fino a una temperatura di -27°C, trascorsa un'ora dall'alimentazione.



Solidi



CERTIFICATO ATEX PER POLVERI ZONA 20/21

INDICATORE DI LIVELLO

PFG05

Linea di prodotto: **Rotativo**



Solidi

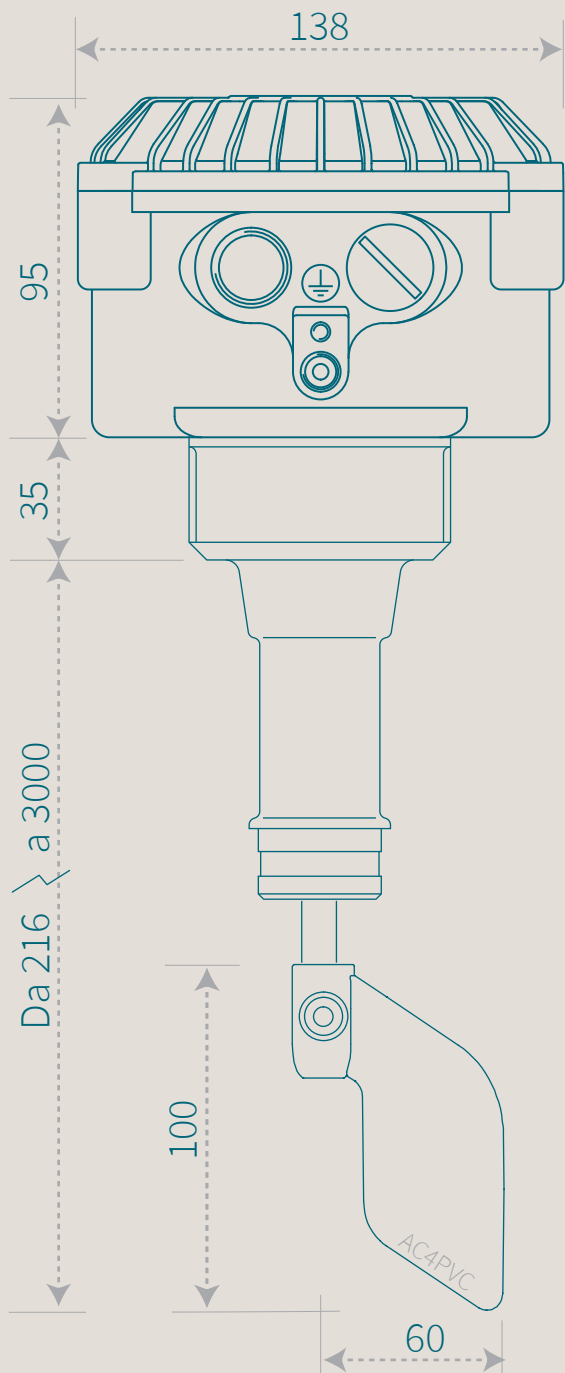

Personalizzazioni

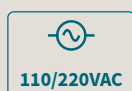

110/220 V AC

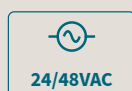

24/48 V AC



24 V DC



Controllo tensione



Doppio contatto



8 impulsi



4 RPM



Basse temperature

Lampada



220VAC



110VAC



24VAC



24VDC

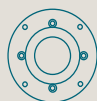

Flangia
in alluminio

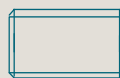

Manicotto
ferro 2"1/2Gas

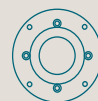

Flangia
acciaio inox

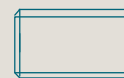

Manicotto
inox 2"1/2Gas



Prolunga e protezione in ferro
da 216 a 3000 mm



Prolunga e protezione in inox
da 216 a 3000 mm

In acciaio inox



AC1



AC3



AC4



AC5



AC5L



AC6



AC7

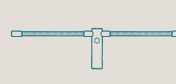

AC8

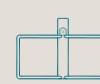

AC9



AC10



AC11



AC12



AC14



AC15

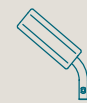

AC16

In Nylon6



AC1



AC2



AC4



AC9



AC13

