



MEMOLUB®



CATALOGUE

The world leading automatic lubrication system

Applications

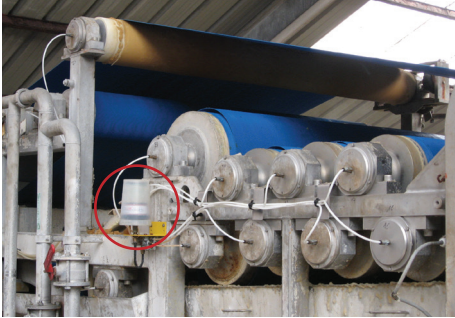

Food industry: lubrication of press ball bearings.



Automotive industry: lubrication of aerial conveyor belt rollers and rails.



Mineral industry: lime factory: lubrication of 4 screw drive bearings.



Textile industry: Picanol weaving loom bearings.



Mineral industry: lubrication of conveyor belt bearings.

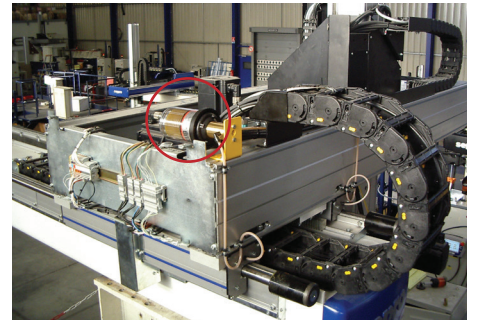

Robotics industry: lubrication of ball guides.



Food waste processing industry: cabinet of Memolubs for the lubrication of bearings and casing of a rotation fermenter.

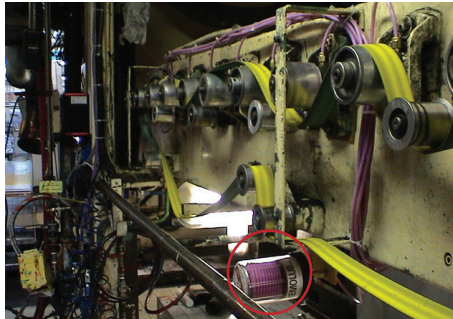

Metal industry: lubrication of return roller bearings on a production machine for aluminium sheets.



Food industry: lubrication of Solyvent Ventec ventilator bearings.

INDEX

Memolub International

4-5

- *About us*
- *History*

The standard in industrial lubrication

6-7

- *The benefits of automatic lubrication*
- *Your advantages*

MLS Products Range

8-19

- *10 bar pressure lubrication systems*
- *25 bar pressure lubrication systems*
- *Case studies*

MLS Accessories

20-23

- *Cartridges*
- *Installation kits*
- *Protection*

DS : The Decentralized Lubrication System

24-27

- *DS system advantages*
- *Case study*

DS accessories

28-29

- *Spare Parts*
- *Installation kits*

Common Accessories

30-33

- *Specific Installations*
- *Tubes and Fittings*

Memolub Services

34

- *Memolub Consulting*
- *Memolub LubeControl*
- *Memolub Trainings*

About us

A technology created to last

Founded in 1987, MEMOLUB® International manufactures and distributes MEMOLUB® lubrication products. For years, the company has been providing innovative and effective lubrication solutions to global industrial players. After more than 15 years selling high performance lubricants, MEMOLUB®'s founder designed a more effective and reliable lubrication system than the spring or gas systems used at the time. This new system based on an electro-mechanical technology ensures outstanding lubrication. Over the years, our objectives remained identical: protect the machinery on the long run by using refillable grease pumps that are both precise and efficient. In order to keep both our objectives and our customers needs fulfilled, MEMOLUB® invests permanently in research and development.

A Swiss touch assembled in Belgium

It is in the industrial zone of Anderlecht in Brussels, in the very same place where Memolub was first created that all MEMOLUB® products are designed, tested and assembled. Willing to work with the best technologies available and to keep our carbon foot print as low as possible, our company partners up with Swiss and Belgian manufacturers to craft MEMOLUB® parts.

A global presence to meet your needs

MEMOLUB® products are currently distributed in 60+ countries in very diverse environments. Based on a flexible technology, MEMOLUB® products suit almost every industrial sector from automobile manufacturers to cement or steel plants. MEMOLUB® also adapts to many situations such as direct-and-remote installations or multi-points applications capable of hundreds of simultaneous grease applications. MEMOLUB® aims to meet to the most technical requirements of its customers.

They trust us



A longtime expertise: 30 years in industrial lubrication

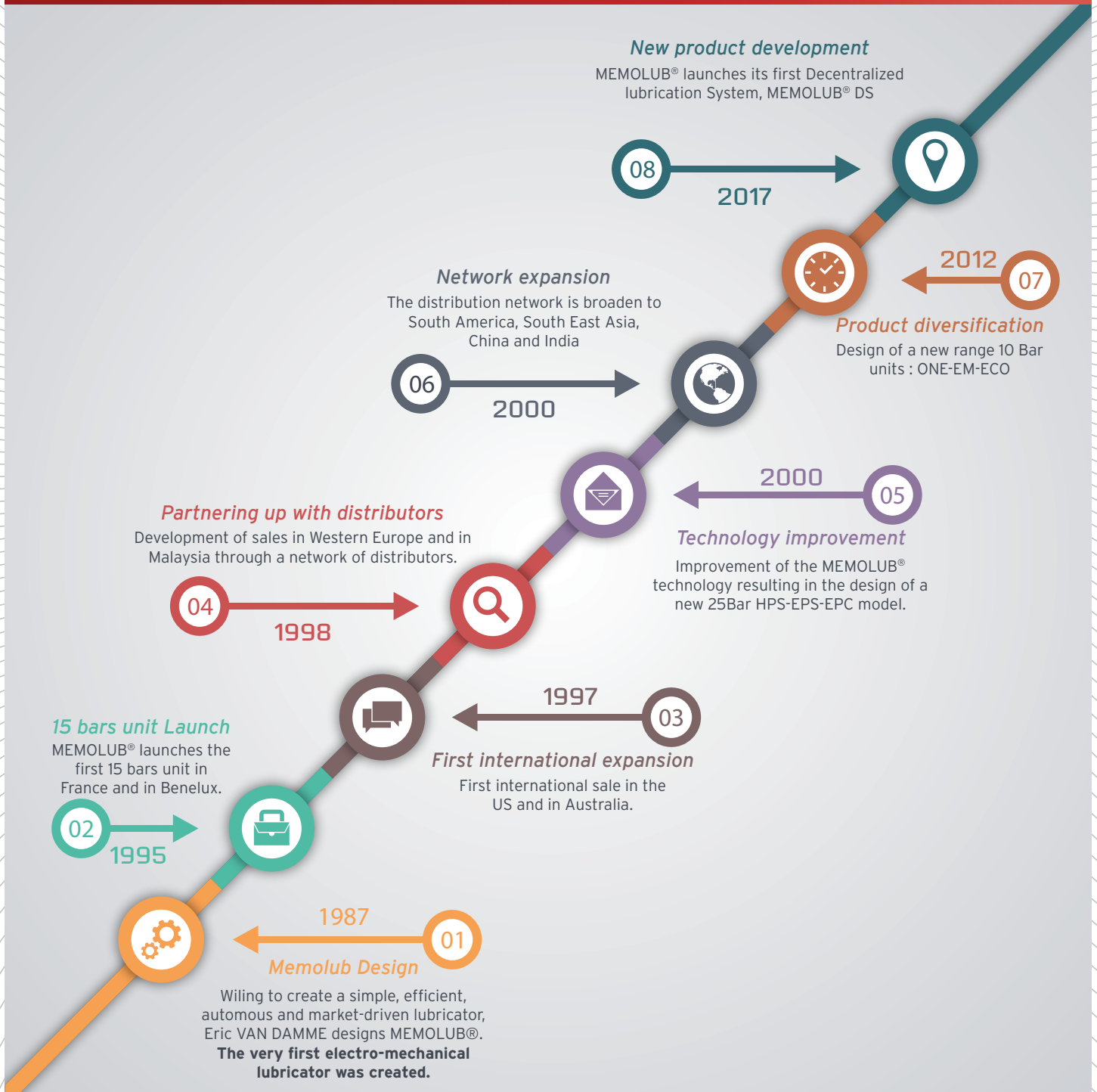

The standard in industrial lubrication systems



The right Lubricant, the right Quantity, at the right Frequency and on the right Place

➤ High-quality lubrication solutions

MEMOLUB® offers a range of class leading single & multi-point lubrication systems, recognized as the benchmark and undisputed reference point for electro-mechanical lubricators. The exceptional features and high quality manufacture of MEMOLUB® offers outstanding protection for lubricated equipment across a wide range of industrial applications.

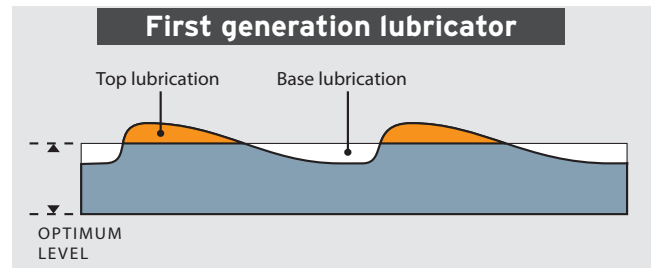
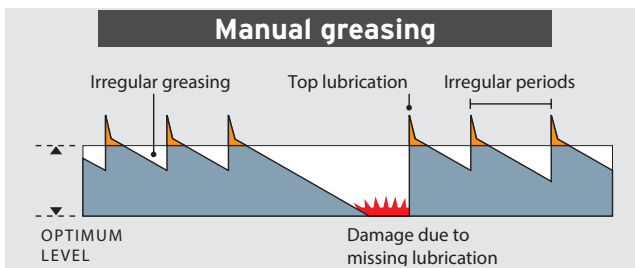

Lubrication with MEMOLUB®

Accurate greasing, frequently and regularly

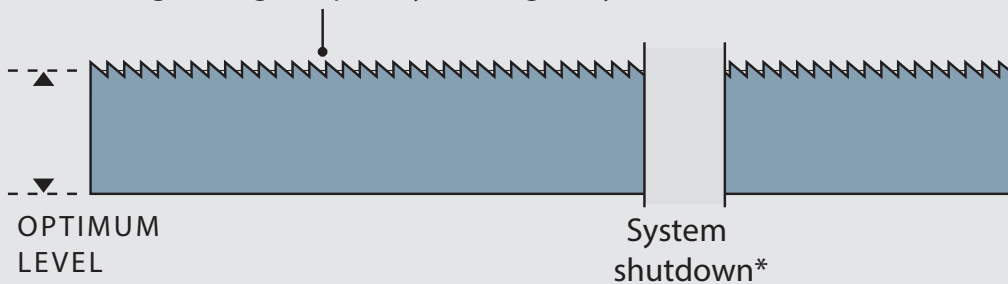

* only with EPS

Industrial components



BEARINGS



CHAINS



LINEAR GUIDANCE



GEARS

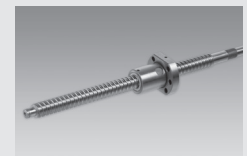

BALL SCREW

Your advantages



ECONOMICAL



- Long-term protection of equipment.
- Increased machines reliability.
- Reduced maintenance costs.
- Increased profitability.
- Wide range of affordable replacement cartridges and battery power packs.

PRECISE AND RELIABLE



- Frequency settings varying from 1 week to 24 months
- Temperature range from -15°C to +50°C
- Patented pump designs
- Industry proven: 25 years' worldwide distribution
- Accurate greasing for each point

EASY TO USE



- Exceptional settings features
- Cartridge change in less than 60 seconds!
- Instant verification offered by transparent housing and check function
- Clean lubrication

SAFE



- Remote installation for difficult or dangerous access points.
- Reduced downtime for lubrication.
- Reduced maintenance interventions.
- Longer replacement intervals.

ECOLOGICAL



- Reusable.
- Unlimited refills.
- Reduced environmental impact.
- Reduced lubricant consumption and improved protection of production equipment.

Applications



CONVEYOR BELT



ROLLING MILL



INCINERATOR



OVEN

MEMOLUB® MLS Lubrication Systems

Memolub® MLS 10 bar

Single-point, reusable and remote lubrication system

EM

2 SETTINGS



ONE

4 SETTINGS

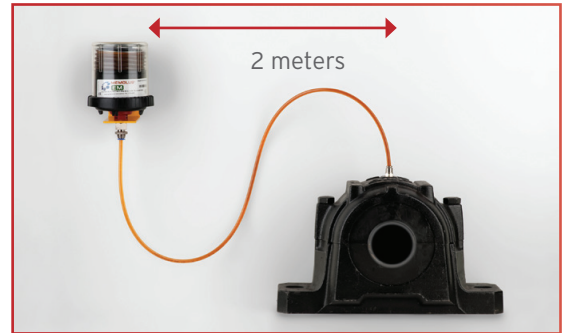

Memolub® MLS 25 bar

Single or multiple points, reusable and remote lubrication system

HPS

4.5V BATTERIES



EPS

24V EXTERNAL POWER SUPPLY



PLCD

24V EXTERNAL POWER SUPPLY PLC DRIVEN

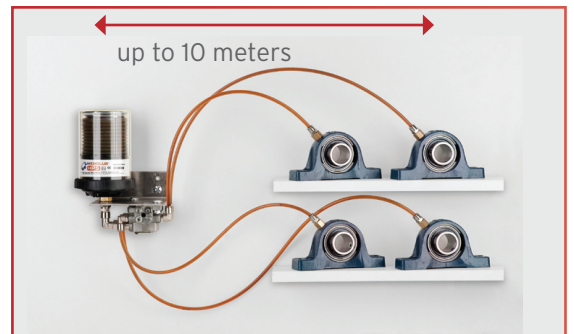

The dosing pump and the Memo

➤ A powerful and efficient pump

- Dosing pump with adjustable output.
- Lubricant ejection pressure of 10 and 25 bar.
- High-performance pump able to pump lubricants at extreme temperatures and with high viscosity.

4.5V Batteries
(Optional external
24 V power supply)

Dosing piston
Opens the check valve.
Standard quantity:
0.6 cc

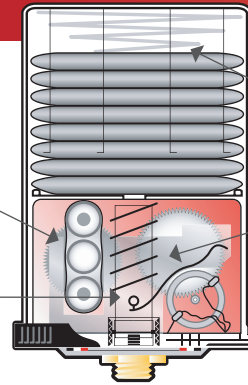

Compression spring

Ejection spring:
10 or 25 bar

10 bar & 25 bar

➤ The MEMO: Smart Setting

- The patented Memo system adjusts the lubricant output frequency.
- The output frequency can be adapted on demand.
- The settings are independent from the body and the cartridge.



- Only one screwable part specifies the lubrication program

- Programming the MEMO with a combination of 3 coloured rings: black, white and red

Memo 10 bar

Memo 25 bar

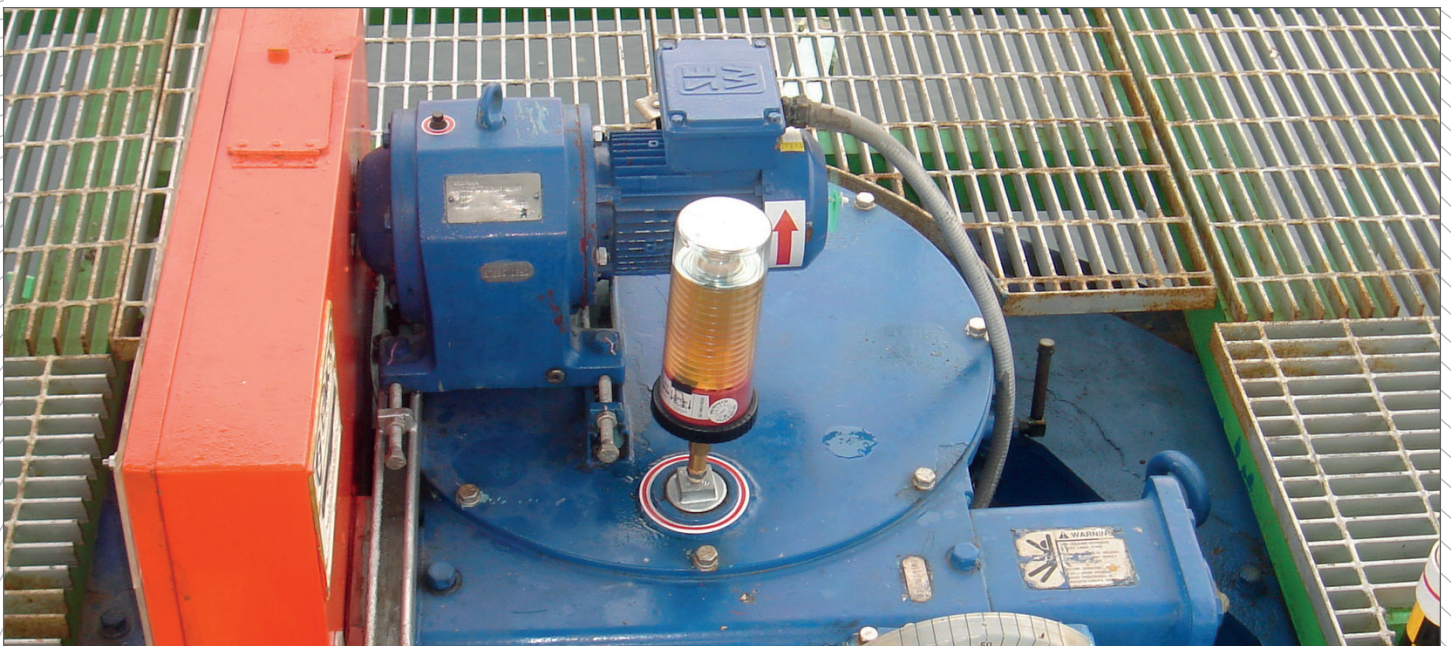

MEMOLUB[®] EM

- *single point*
- *10 bar pressure*
- *remotely installed up to 2 meters*
- *2 settings (1 year and 2 years)*



Why MEMOLUB[®] EM



Meet our new generation automatic single point lubricator. Its patented technology secures a precise, regular and reliable lubrication.

3 to 4 times more powerful, it is the uncontested replacement of conventional gas lubricators. Ideal for small bearings, electric motors, conveyors, ventilators and pumps.

Most economic lubricator on the market. EM is refillable: the only replaceable consumables are plastic recyclable refills and set of batteries. Limited impact to the environment.

Technical specifications

Cartridge capacity	120 cc
Maximum stroke pressure	10 bar / 140 psi
Batteries	4.5 V DC Alkaline battery
Remote Installation	Up to 2 metres - Ø 8mm tubing
Lubricants	Oil and grease (up to NLGI 2 with an oil base between 100 and 460 cSt)
Operating temperature	-15°C to 50°C*
Connections	1/4 BSP

* Batteries + lubricant adapted to low temperatures

MEMO adjustments

	⊘	⊘
Adjustments	2 years	1 year
Average daily output	0.15 cc/day	0.3 cc/day

Product Reference

Product	Reference
MEMOLUB EM EX II	6130



EM Application

Automobile industry

APPLICATION

- Regular manual lubrication
- Robots on an assembly line

PROBLEMS

- Regular manual lubrication
- Production line shutdown required for lubrication
- High maintenance costs

SOLUTION

- Installation of one MEMOLUB® **EM** per robot
- Frequency : one year

RESULTS

- Human intervention was divided by 3 along with the costs related to it
- Due to good results after three months, the company decided to install other MEMOLUB® HPS products on their assembly line

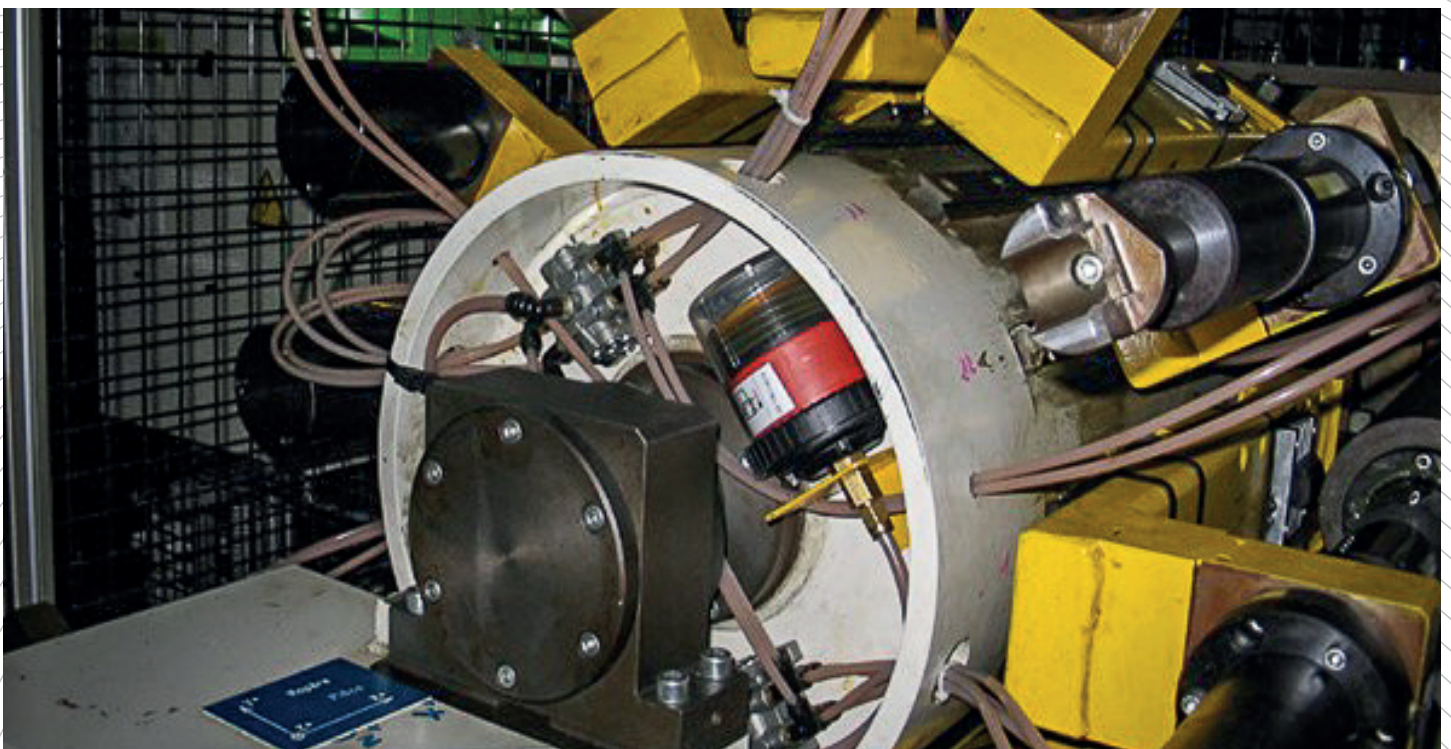

MEMOLUB® ONE

- single point
- 10 bar pressure
- remotely installed up to 2 meters
- 4 settings (1 month to 12 months)



Why MEMOLUB® ONE



New generation of automatic lubricators. 4 programs to choose. Its reliability makes it the best performing mono-point lubricator in the market.

It is designed to work under extreme conditions such as in the mineral, cement or metal industries. It is ideal for applications where over-lubrication is necessary in order to protect the bearing against the external environment.

Most economical device in the market. EM is refillable: the only replaceable consumables are plastic recyclable refills and set of batteries. Limited impact to the environment.

Technical specifications

Cartridge capacity	240 cc
Maximum stroke pressure	10 bar / 140 psi
Batteries	4.5 V DC Alkaline battery
Remote Installation	Up to 2 metres - Ø 8mm tubing
Lubricants	Oil and grease (up to NLGI 2 with an oil base between 100 and 460 cSt)
Operating temperature	-15°C to 50°C*
Connections	1/4 BSP

* Batteries + lubricant adapted to low temperatures

MEMO adjustments

	⊘	⊘	⊘	⊘
Adjustments	1 year	6 months	3 months	1 month
Average daily output	0.6 cc/day	1.2 cc/day	2.4 cc/day	7.2 cc/day

Product Reference

Product	Reference
MEMOLUB ONE EX II	6110



Starter Pack MEMOLUB® ONE

Unpack, Screw in, it lubricates !

The MEMOLUB® ONE Starter Pack is a ready-to-use single point, autonomous and refillable lubrication system.

This set includes:

- 1 MEMOLUB® ONE and its replaceable multi-purpose grease MEMOMULTI 2 cartridge
- 1 offset kit with fittings, mounting bracket and 2m prefilled tubing

Product Reference

Product	Reference
MEMOLUB ONE EX II w/ grease	6115
MEMOLUB ONE EX II w/out grease	6120

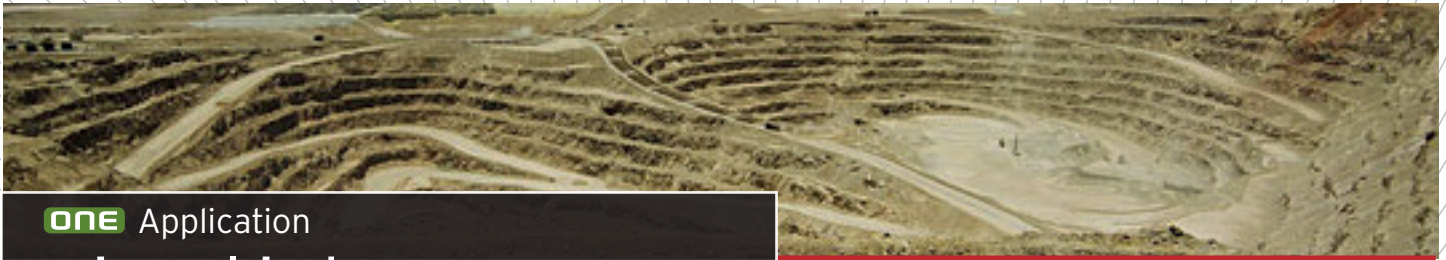

ONE Application

Mineral industry

APPLICATION

- Industrial crusher
- Bearings are lubricated by chemical lubrication systems (12 per year) (20€ each)
- Frequency : 1 month

PROBLEMS

- The chemical greaser operates randomly
- The counter-pressure is too high for the bearing to be lubricated properly

SOLUTION

- Remote installation of two MEMOLUB® **ONE**
- Frequency : 3 months

RESULTS

- A more precise lubrication (exact output of 2.4 cc/day)
- Labour savings (divided by 3)
- Environmental impact reduced (consumables divided by 3)

ECONOMICAL OUTCOME

	Chemical System	ONE
First Year Total	12 x 20 x 2 = 800€	240 (initial investment) + (4 x 15 x 2) = 360€
Total after 3 years	2.400€	600€
Average Yearly Cost (3-year period)	800€	240€
Yearly Savings over 3 years		90.8%



MEMOLUB® HPS

- 25 bar pressure
- single or multi-points
- can be used with 1 to 8 outlets
- remote installation up to 8 meters



Why MEMOLUB® HPS



With a 25 bar expulsion pressure, this autonomous model is the most versatile unit in its range.

Frequency is set once and then it is regulated by the MEMO. Maintenance staff does not need to worry of setting anymore, this facilitates greatly lube organisation.

Ideal for all types of industrial applications : bearings, open gears, chains, rollers...

Most economical device in the market. EM is refillable: the only replaceable consumables are plastic recyclable refills and set of batteries. Limited impact to the environment.

Technical specifications

<i>Cartridge capacity</i>	120 cc, 240 cc or 480 cc
<i>Maximum stroke pressure</i>	25 bar / 250 psi
<i>Batteries</i>	4.5 V DC Alkaline battery
<i>Remote Installation</i>	Up to 8 metres/ single point - Ø 8mm tubing
<i>Lubricants</i>	Oil and grease (up to NLGI 2 with an oil base between 100 and 460 cSt)
<i>Operating temperature</i>	-15°C to 50°C*
<i>Connections</i>	1/4 BSP
<i>Distribution</i>	Progressive distribution from 1 to 8 outputs

* Batteries + lubricant adapted to low temperatures

MEMO adjustments

	<input type="checkbox"/> <input checked="" type="checkbox"/> <input type="checkbox"/>	<input type="checkbox"/> <input checked="" type="checkbox"/>	<input type="checkbox"/> <input type="checkbox"/> <input checked="" type="checkbox"/>	<input type="checkbox"/> <input checked="" type="checkbox"/>	<input checked="" type="checkbox"/> <input type="checkbox"/>	<input type="checkbox"/> <input type="checkbox"/> <input checked="" type="checkbox"/>	<input type="checkbox"/> <input checked="" type="checkbox"/>	<input checked="" type="checkbox"/>
<i>Daily ejection</i>	24	12	4	2	1.5	1	0.5	
<i>Dailout output in cc</i>	14.4	7.2	2.4	1.2	0.9	0.6	0.3	

Product Reference

<i>Product</i>	<i>Reference</i>
MEMOLUB HPS 120cc EX II	6000
MEMOLUB HPS 240cc EX II	6001
MEMOLUB HPS 480cc EX II	6002



HPS Application

Steel industry

APPLICATION

- Oven
- Torsion bar & Gear shaft
- Centralized automatic lubrication

PROBLEMS

- Unflexibility of the system
- Same amount of grease for both mechanical components: the torsion bar was over-lubricated

SOLUTION

- MEMOLUB® **HPS** MEGA 240cc + Distributor Block 4 outlets
- MEMOLUB® **HPS** GIGA 480cc + Distributor Block 2 outlets
- Frequency : 6 months

RESULTS

- Volume adapted for each component
- Lubricant annual consumption divided by 6
- Less consumables (eco-friendly)
- Good results and client satisfaction for more than 16 years !



MEMOLUB[®] EPS

- single or multi-points
- external power source 24 V DC
- can be used with 1 to 8 outlets
- remote installation up to 8 meters



Why MEMOLUB[®] EPS



Its external power supply is the ideal solution for applications that are not working continuously. Directly linked to the power supply of the machine, the EPS model only lubricates when the machine is running.

Ideal for all types of industrial applications : bearings, open gears, chains, rollers,... It can also be used in very cold environments.

Most economical device in the market. EM is refillable: the only replaceable consumables are plastic recyclable refills and set of batteries. Limited impact to the environment.

Technical specifications

Cartridge capacity	120 cc, 240 cc or 480 CC
Maximum stroke pressure	25 bar / 250 psi
Batteries	External 24 V DC
Remote Installation	Up to 8 metres / single point - Ø 8mm tubing
Lubricants	Oil and grease (up to NLGI 2 with an oil base between 100 and 460 cSt)
Operating temperature	-15°C to 50°C*
Connections	1/4 BSP
Distribution	Progressive distributor for 4, 6 and 8 outputs

MEMO adjustments

	<input checked="" type="checkbox"/> <input type="checkbox"/> <input type="checkbox"/>	<input checked="" type="checkbox"/> <input type="checkbox"/>	<input checked="" type="checkbox"/> <input checked="" type="checkbox"/>	<input checked="" type="checkbox"/>	<input type="checkbox"/> <input type="checkbox"/>	<input type="checkbox"/> <input checked="" type="checkbox"/>	<input type="checkbox"/>
Daily ejection	24	12	4	2	1.5	1	0.5
Dailout output in cc	14.4	7.2	2.4	1.2	0.9	0.6	0.3

Electrical characteristics

Power supply	Ext..	Stroke duration	4 sec
Output voltage	24 V DC	Min. time between strokes	1 hour
Output current	< 0.5 A	Max. cable lenght	10 m
Short Circuit Protection	ok	Power cable	2 x 0.5 mm ²

Product Reference

Product	Reference
MEMOLUB EPS 24V 120cc	6020
MEMOLUB EPS 24V 240cc	6021
MEMOLUB EPS 24V 480cc	6022

*lubricant adapted to low temperatures



EPS Application
Food industry

APPLICATION

- Cheese press machine
- Lubrication via 12 chemical autonomous lubricators (**52€ each**)
- one lubricator for each lubricating point
- Frequency : 3 months

PROBLEMS

- Difficult access to each lubricator
- Over lubrication creating contamination on the machine parts
- Costly lubrication solution

SOLUTION

- 2 MEMOLUB® **EPS**
- Extension kit + Block Distributor 6 outlets per MEMOLUB®
- Frequency : 4 strokes/day ; 3 months

RESULTS

- Precise lubrication (2.4 cc daily)
- Maintenance is easier (2 cartridges instead of 12)
- Environmental impact is reduced (6 times less consumables)

ECONOMICAL OUTCOME		EPS
	Chemical System	
First Year Total	12 x 52 x 4 = 2.496€	832 (initial investment) + (4 x 9.2 x 2) = 905,6€
Total after 3 years	7.488€	1.052,8€
Average Yearly Cost (3-year period)	2.496€	498,1€
Yearly Savings over 3 years		95%

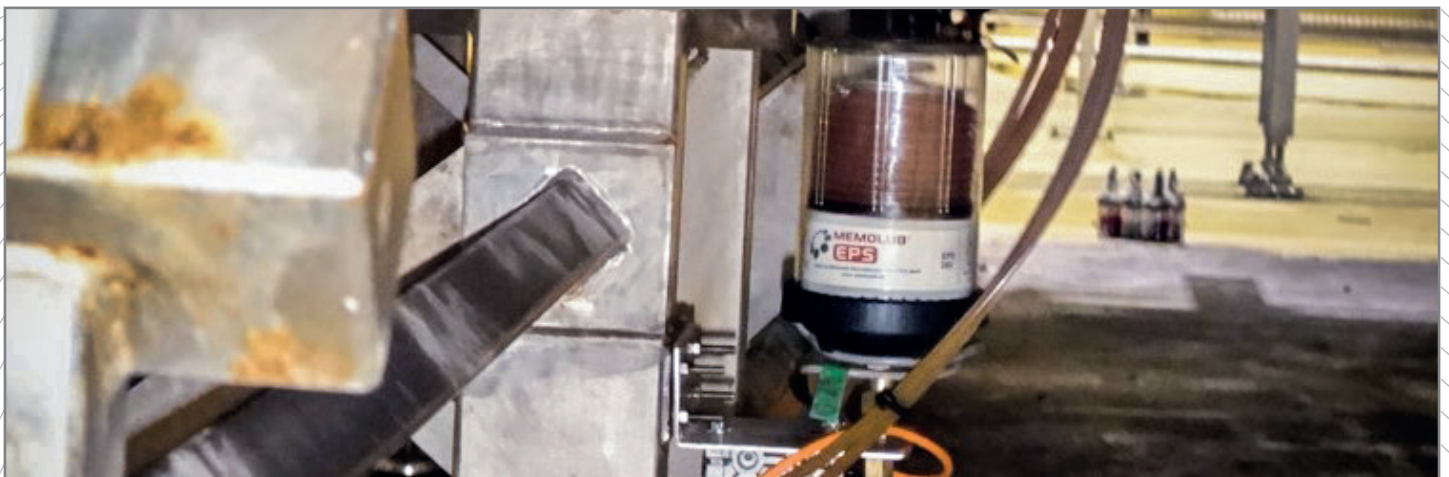

MEMOLUB[®] PLCD

- *single or multi-points*
- *programmable with PLC*
- *can be used with 1 to 8 outlets*
- *remote installation up to 8 meters*



Why MEMOLUB[®] PLCD

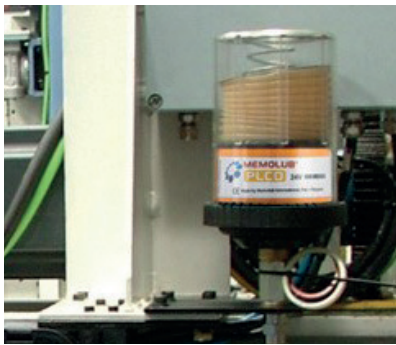

The PLCD model suits any of your requirements. Directly linked to the PLC, PLCD will permanently receive information which will enable the lubricating point to receive the right amount of lubricant at the right time.

Its external power supply with a Programmable Logic Controller (PLC) is the ideal solution for applications that request tailored lubrication.

Most economical device in the market. EM is refillable: the only replaceable consumables are plastic recyclable refills and set of batteries. Limited impact. Ideal for OEM machines : robots, conveyors,...

Technical specifications

<i>Cartridge capacity</i>	120 cc, 240 cc or 480 CC
<i>Output settings</i>	Unlimited settings by PLC
<i>Maximum stroke pressure</i>	25 bar / 250 psi
<i>Batteries</i>	External 24 V DC
<i>Remote Installation</i>	Up to 8 metres/ single point - Ø 8mm tubing
<i>Lubricants</i>	Oil and grease (up to NLGI 2 with an oil base between 100 and 460 cSt)
<i>Operating temperature</i>	-15°C to 50°C
<i>Connections</i>	1/4 BSP
<i>Control detector</i>	Progressive distributor for 4, 6 and 8 outputs

*lubricant adapted to low temperatures

Electrical characteristics

<i>Power supply</i>	Ext..	<i>Stroke duration</i>	4 sec
<i>Output voltage</i>	24 V DC	<i>Min. time between strokes</i>	10 min
<i>Output current</i>	< 0.5 A	<i>Max. cable lenght</i>	10 m
<i>Short Circuit Protection</i>	ok	<i>Power cable</i>	2 x 0.5 mm ²

Product Reference

<i>Product</i>	<i>Reference</i>
MEMOLUB PLCdriven 120cc (24V)	6010
MEMOLUB PLCdriven 240cc (24V)	6011
MEMOLUB PLCdriven 480cc (24V)	6012



PLCD Application
Food industry

APPLICATION

- Conveyor chains
- Lubrication via an electro-mecanical autonomous lubricator on a battery set

PROBLEMS

- Difficult access to the lubricator
- Under lubrication creating machine shutdowns
- Costly lubrication solution

SOLUTION

- 1 MEMOLUB® **PLCD**
- Extension kit + brushes
- Frequency : PLC-driven

RESULTS

- Precise lubrication (PLC-driven)
- Maintenance is easier (remote installation with brushes)
- Lubrication system switch generating significant savings from **1.698€/y to 544€/y**



Lubricant cartridges and protection cover

Lubricant cartridges

- • Please use MEMOLUB® cartridges only
- With the batteries, the cartridges are the only consumables: once empty, please treat them ecologically
- MEMOLUB® works only with cartridges filled correctly: Do not (re)fill cartridges by yourself
- Please contact your local MEMOLUB® dealer for available lubricants

MEMOLUB® cartridges are filled by spinning to secure air-free lubricants

When reordering the MEMOLUB® replacement kits, we are often asked «How do I know what size cartridge I have?»

Well here are a couple of easy ways to know.

Option 1

On the clear outer housing each MEMOLUB® lubricator is labeled with the appropriate model number depicting the volume of lubricant in the cartridge.

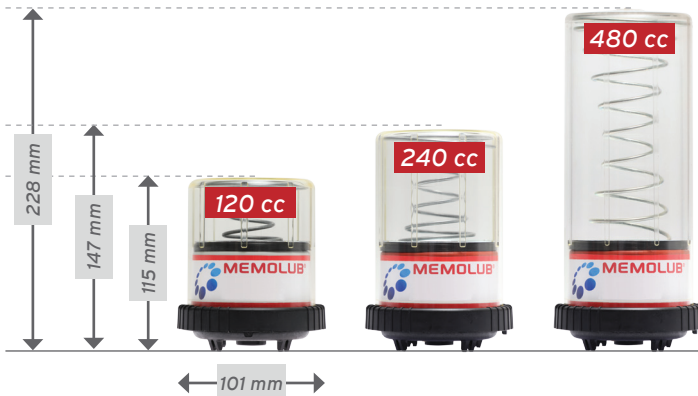

Option 2

Count the number of “Ribs” of the cartridge bellows.

The MEMOLUB® lubricant cartridges are common among all the MEMOLUB® Model Lubricators: EM, ONE, HPS, EPS and PLCd.

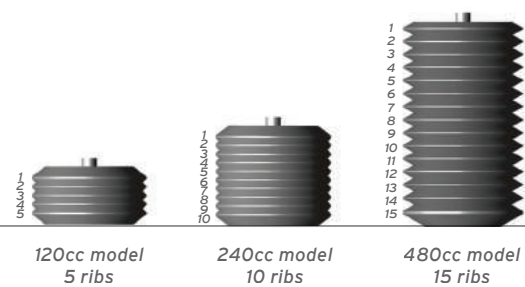

Protection cover

Our protection covers brings to MEMOLUB® an optimal protection in hostile atmospheres against:

- Water (Heavy rains or recurrent washing)
- UV (sun)
- Small falling objects



Spare parts

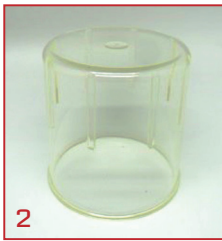

2
Transparent housing



3
Locking ring



4
Compression disc



5
Transparent housing for refill kit



6
Battery pack



7
Battery seal



8
Kit Memo 10 bar



9
Memo screw



10
Memo HPS Kit



11
Check valve Memo HPS/Brush

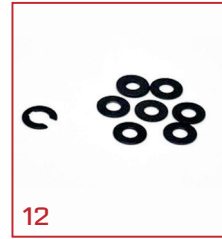

12
Volumetric rings



13
Screw Connection EPS

Accessories	Pic	Reference	Specifications
PROTECTION COVER			
Protection Cover 120-240cc	1	2211	Protection against hostile atmospheres
Protection Cover 480cc	1	2212	
TRANSPARENT HOUSING KIT FOR REFILL			
Transparent housing PA12 120cc	2	2208	Transparent housing in polyamide for UV and aggressive environments. 120-240cc
Transparent housing PA12 240cc	2	2209	
Transparent housing PA12 480cc	2	2210	
Locking ring	3	2203	Locking ring
Compression disc	4	2204	Compression disc
Kit 120cc PA12	5	1204	Transparent housing PA12, locking ring, spring and compression disc , battery seal 120-240cc
Kit 240cc PA12	5	1205	
Kit 480cc	5	1203	Transparent housing, locking ring, spring and compression disc, battery seal 480cc
BATTERIES			
Battery pack*	6	5001	3*1.5VDC Alcaline battery pack
Battery seal	7	2206	Rubber protection ring
MEMO HPS KIT AND ACCESSORIES			
Memo HPS 10 bar Kit	8	2801	4 Memo's to set frequency on EM and ONE
Memo screw	9	1301	Memo screw
Memo HPS 25 bar Kit	10	1101	Memo screw, Memo ring holder, Frequency rings for MEMOLUB® HPS and EPS
Check valve Memo HPS	11	2800	For using into Memo HPS. It blocks oil return
Volumetric rings	12	2401 2402	For using into Memo HPS. It adjusts the quantity per stroke
Screw Connetion EPS	13	1550	Screw Connection for MEMOLUB® EPS

* only sold by 5

MEMOLUB® HPS installation kits and accessories

Extension Kits

- Remote installation up to 2/8 meters (10bar/25bar)
- Ideal for a difficult acces
- Ideal for a lubrication point subject to vibrations



1 EXTENSION KIT FOR 10BAR

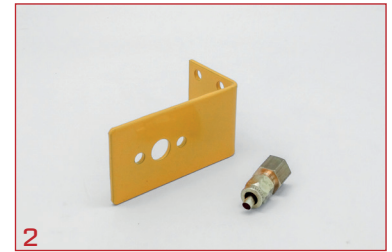

2 EXTENSION KIT FOR 25BAR

Distributor Kits

Transform MEMOLUB® HPS into a small centralised lubrication system !

- Validated by MEMOLUB®
- Continous low pressure
- Up to 8 points and 6 meters¹
- Nearly no pressure loss
- Equal output for each outlet (0.3cc)



3 DISTRIBUTOR BLOCK

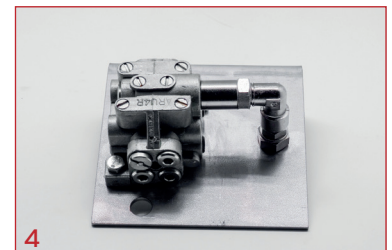

4 DISTRIBUTOR KIT

¹ tested with NLG2 multipurpose grease

Proximity Switch

Equipped with a magnetic sensor, the proximity switch provides lubrication feedback. Fixed with stainless tools, it resists easily difficult environments.



5 PROXIMITY SWITCH
INSTALLATION KIT



6 PROXIMITY SWITCH

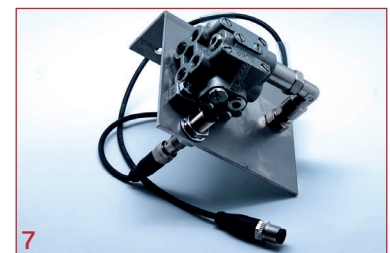

7 DISTRIBUTOR KIT WITH A
PROXIMITY SWITCH

MEMOLUB® HPS installation kits and accessories

Accessories for Distributor Block



8

BRIDGING ELEMENT



9

CHECK VALVE DB

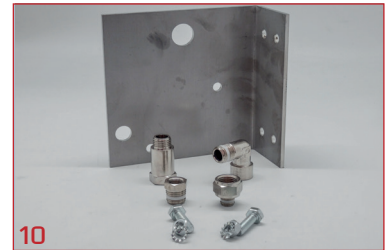

10

INSTALLATION KIT DB

- Block one outlet
- Double the output of one outlet

Accessories	Pic	Reference	Specifications
EXTENSION KIT			
Extension Kit for 10bar	1	1108	Mounting Bracket, Fittings for fixation
Extension Kit for 25bar	2	1508	Mounting Bracket, adaptor G1/4 for tube 8mm
DISTRIBUTOR KIT			
DB4	3	2701	Distributor Block 4 outlets
DB6	3	2702	Distributor Block 6 outlets
DB8	3	2703	Distributor Block 8 outlets
Distributor Kit 2 outlets (DB4 + 2 Y fittings)	4	1509	Installation kit for DB, distributor block, bracket & 2 push-in G1/8 per outlet
Distributor Kit 4 outlets	4	1505	
Distributor Kit 6 outlets	4	1506	
Distributor Kit 8 outlets	4	1507	
PROXIMITY SWITCH			
Proximity Switch Installation Kit	5	2552	Sensor for lubrication feedback
Proximity Switch Cable 60 cm	6	2553	Proximity Switch Cable 60 cm
Distributor Kit 4 with a Proximity Switch	8	1544	Proximity switch already installed on a kit distilube
Distributor Kit 6 with a Proximity Switch	8	1546	
Distributor Kit 8 with a Proximity Switch	8	1548	
ACCESSORIES			
Bridging Element	8	2705	Bridging element for Distributor Block
Check Valve DB	9	2800	For using into DB. It blocks oil return
Installation Kit DB	10	1520	Installation Kit for Block Distributor

MEMOLUB[®] DS

DECENTRALIZED LUBRICATION SYSTEM

- Low pressure lubrication system
- Multi-setting dosing pump
- Simple usage
- For all types of industries



Why MEMOLUB[®] DS



Our decentralized lubrication system based on a pressurized air technology suits any type of applications. Pumps and the electronic system can be remotely installed respectively up to 20 meters and 1km which allow the user to safely control and manage its lubrication process.

The DS model is designed to preserve lubricants performance. The low pressure lubrication system prevents lubricants deterioration while allowing up to 20 different lube points per pump.

Affordable installation and reduced maintenance costs guarantee a quick return on investment.

Dosing Pump			
Technical data		Pump 18kg	Pump 50kg
Pump ratio		20/1	20/1
Input air pressure	bar	6	6
T1 / T2 thread	BSP	F 1/8"G	F 1/8"G
T1 tubing	mm	Ø 6 - 8	Ø 6 - 8
T2 tubing	mm	Ø 4 - 6	Ø 4 - 6
Lube output thread	BSP	M 1/2"G	M 1/2"G
Diameter rod	mm	Ø 30	Ø 30
Expulsion per stroke	cm ³	4,5	4,5
Lenght rod (L)	mm	530	780
Packaging / container	kg	18-30	50-60
Weight dosing pump	kg	5,10	6,50

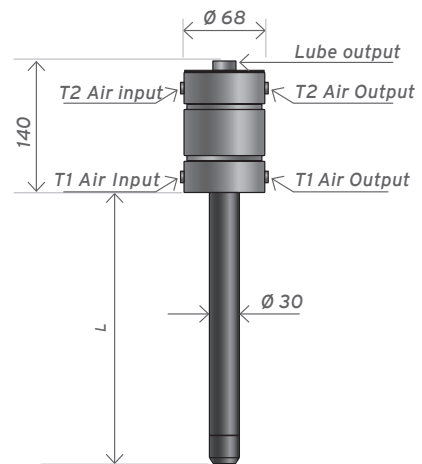

Decentralized Electronic Box			
Box: 2 versions	24 VDC / 220 VAC 50Hz	Pneumatic input	6 bar
Box dimensions	400 x 200 x 132 mm	Operating temperature	-20°C to +55°C (-4°F to 131°F)
Supply voltage	24DC / 240 VAC - Min 0,3A - Max 0,55A	Air output -transfer tube (T2)	8 mm
Electric circuit protection	Breaker 6A	Air output -expulsion tube (T1)	6mm
Electric cable for 240VAC	3G1.5 type H07RNF (a)	Weight electronic box	1 kg

Product Reference	
Product	Reference
DS 18 Pump	1800
DS 18 Pump	1801



DS Application

Chemical industry

APPLICATION

- Industrial dryer 43
- Lubrication by spraying two riding rings and the transmission chain

PROBLEMS

- The centralized system in place does not work which leads to an extra annual maintenance cost (**4.000€**)
- The transmission chain has to be replaced every year (**8.000€**)

SOLUTION

- 1 MEMOLUB® **DS** with KL23 on the chain
- 1 MEMOLUB® **DS** with SF HEAVY on the riding rings
- Frequency : 6 months

RESULTS

- Precise lubrication (100g/day)
- Maintenance is easier (human intervention only twice a year)
- Environmental impact is reduced (less consumables)

ECONOMICAL OUTCOME

	Previous System	DS
Initial investment	0€	4.200€
Lubricant Cost per year	N.A.	1.000€
Yearly Maintenance Cost	4.000€	0€
Yearly Replacement Cost	8.000€	0€
Average Yearly Cost (3-years period)	12.000€	2.406€
Yearly Savings over 3 years		92.8%

Multi-point automatic lubrication suitable for one or several lubricants

DECENTRALIZED ELECTRONIC BOX

- Control panel with frequency settings
- Power supply 24 VDC / 240 VAC / Customer PLC
- Power supply 6 bar air pressure
- 1 control panel for several pumps
- Lubrication monitoring (optional)

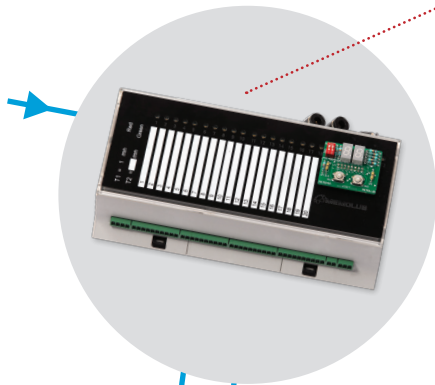

COMPRESSED AIR

FLEXIBLE TUBING

HIGH PERFORMANCE PATENTED PUMP



- Dosing pump powered by compressed air
- Available for different standard packaging
- 2.25 cc / 3.375 cc / 4.5 cc per stroke
- Adjustable output of 2.25 cc to 648 cc / day
- For oil viscosity ISO VG 220 to 4000
- For Grease NLGI 2 max
- 2 air outlets to supply additional pumps in series

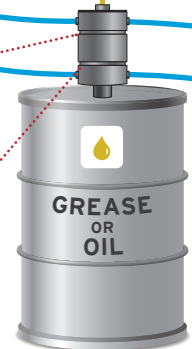
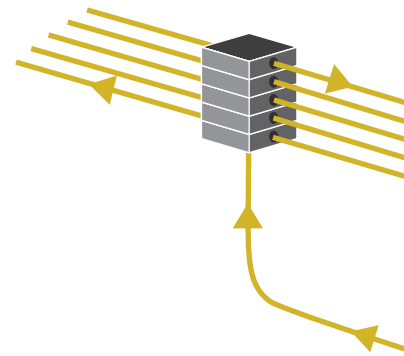

MULTI-FLOW

- Adjustable flow setting per pump
- Settings 100%, 75%, 50% of 4.5 cc per stroke

system, with adjustable flow, ants simultaneously

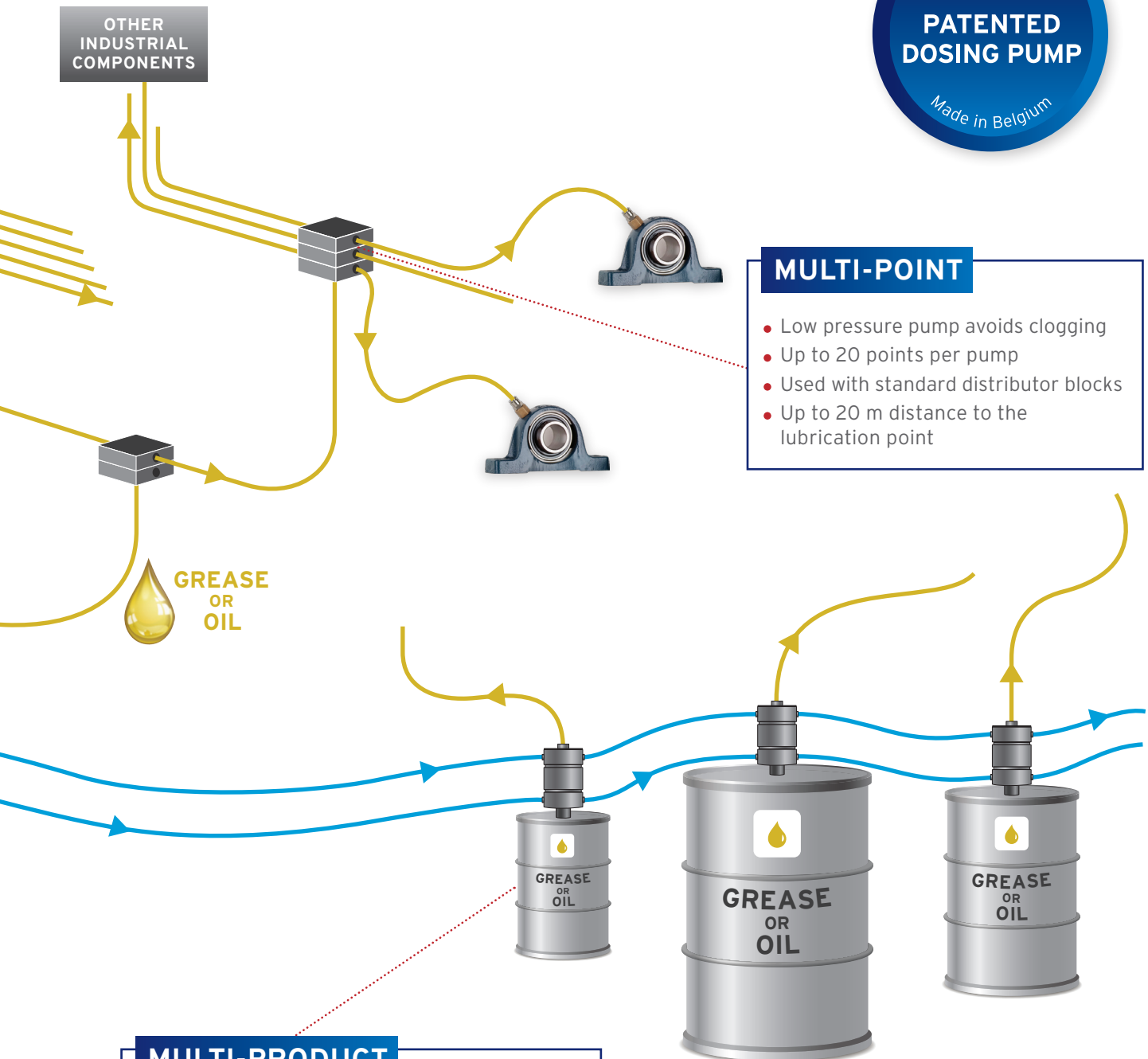

MULTI-POINT

- Low pressure pump avoids clogging
- Up to 20 points per pump
- Used with standard distributor blocks
- Up to 20 m distance to the lubrication point

MULTI-PRODUCT

- Usable with standard packaging
- Environmentally friendly
- Unlimited number of lubricants per installation

MEMOLUB® DS accessories

Basic DS System Spare Parts

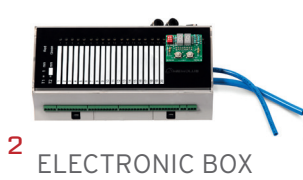

Distributor Blocks



Tubes and Fittings

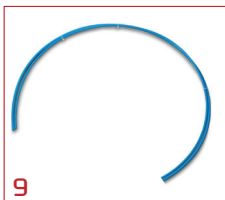

MEMOLUB[®] DS accessories

Accessories	Pic	Reference	Specifications
BASIC DS SYSTEM SPARE PARTS			
DS 18 Pump	1	1800	DS Pump for 18kg pails
DS 50 Pump	1	1801	DS Pump for 50kg pails
Electronic box DS 230V	2	2870	Electronic box DS 230V
Electronic box DS 24V	2	2875	Electronic box DS 230V
Check function control	3	2876	5m control cable for manual check function
DS Cover Ø320mm Lid 18-30kg	4	2864	Lid to lock the DS pump on the pail
DS Follower Plate 18-30kg (Castrol version)	5	2865	Standardized Follower Plate for 18-30kg Castrol pails
DS Follower Plate 18-30kg (other lubricant) ¹	5	1806	Taylor-made Follower plate for 18-30kg pails
DS 18 Installation kit	6	1810	Installation kit for DS 18
DISTRIBUTOR BLOCKS AND ACCESSORIES			
DS Block 2 S + Visual Indicator	7	2360	DS Distributor Block Volume per outlet: 0.1cc
DS Block 4 S + Visual Indicator	7	2361	
DS Block 6 S + Visual Indicator	7	2362	
DS Block 8 S + Visual Indicator	7	2363	
DS Block 10 S + Visual Indicator	7	2364	
DS Block 12 S + Visual Indicator	7	on demand	
DS Block 14 S + Visual Indicator	7	on demand	
DS Block 16 S + Visual Indicator	7	on demand	
DS Block 18 S + Visual Indicator	7	on demand	
DS Block 20 S + Visual Indicator	7	on demand	
DS Proximity Switch	8	on demand	Sensor for lubrication feedback installed on DB
TUBES AND FITTINGS			
DS Tube Rilsan blue/air 6x8mm	10	2791	Air tube between electronic box and DS pump
DS Tube Rilsan blue/air 4x6mm	10	2792	
DS Tube high pressure 350 bar - 8x14.3mm	11	2793	Tube and fittings between DS pump and distributor blocks High pressure components
DS Fitting high pressure fem 8x14.3mm	12	2872	
DS Fitting high pressure mal 8x14.3mm	12	2873	
Tube 6/8mm (roll of 100m)	13	2723	Tube and fittings between DS divider block and lubrication points
Push-in 1/8 T8/6mm	14	2724	
Elbow Fitting D8 1/8	15	2711	

¹ on demand

Common accessories

Rail crane

- Precise and accurate lubrication of rails
- Rails are entirely lubricated (also to the sides)
- Mitigate frictions due to overhead crane misalignments
- Reduce rails deterioration
- Guaranteed return on investment



A RAIL CRANE APPLICATION : STEEL INDUSTRY



APPLICATION

Rail and roller lubrication of an overhead crane

PROBLEMS

Shorter rail and roller lifetime due to excessive wear resulting in overhead crane stoppage and production losses. Rollers had to be replaced every 12 to 18 months at a total cost of 9.018€

SOLUTION

- Installation of MEMOLUB® HPS MEGA with a crane rail lubricator
- Frequency : 3 months

RESULTS

- After 24 months, wear on rollers has been stabilized
- No more machine stoppage

Spray Nozzle

- Lubrication over a large surface made easy
- Open gear lubrication made possible
- Ideal for outdoor environments
- Ideal for oil lubrication



A SPRAY NOZZLE APPLICATION : MINING INDUSTRY



APPLICATION

Lubrication of the thread of a pin of a ground drilling machine

PROBLEMS

Premature wear leading to early pin replacement (2000€/pin)

SOLUTION

Installation of MEMOLUB® PLCD MEGA with a spraying system

RESULTS

Wear reduction and longer pin lifetime

Common accessories

Brushes and accessories

The most reliable and economical solution to automate chains lubrication !



3
4
5
NATURAL BRUSH



6
7
NYLON BRUSH



8
INOX BRUSH



9
CHECK VALVE

Brackets



10
MEMO BRACKET

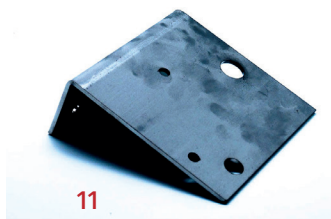

11
DB BRACKET



12
BRUSH BRACKET

Accessories	Pic	Reference	Specifications
GREASE/OIL APPLICATIONS			
Crane Rail	1	3026	Crane Rail
Spray Nozzle	2	2700	Spray Nozzle
BRUSHES AND ACCESSORIES			
Natural brush 15mm	3	2810	Natural brush 15mm + adaptor
Natural brush 30mm	4	2811	Natural brush 30mm + adaptor
Animal brush 50mm	5	2812	Natural brush 50mm + adaptor
Nylon brush flat 30x4mm	6	2813	Nylon Bijur brush flat + adaptor
Nylon brush circular - Ø16	7	2814	Nylon Bijur brush circular + adaptor
Inox brush 16mm	8	2815	INOX brush 16mm + adaptor
Brush Check Valve	9	2801	For using into a brush. It blocks oil return
BRACKETS			
MEMO Bracket	10	2720	Bracket to install Memolub
DB Bracket	11	2760	Bracket to install distributor blocks
Brush Bracket	12	2719	Bracket to install brushes

Common accessories

Tubes



RILSAN PA12 TUBE



CONSOLIDATED
RILSAN TUBE



PTFE TUBE

Fittings



PUSH-IN



ELBOW FITTING



Y FITTING



OLIVE FITTING



OLIVE ELBOW
FITTING

Adaptors and connectors



ADAPTORS M-F



FELT PINION



SILENT BLOCK M6

TOM



- More visible level
- Enable to offset oil leaks up to 1 liter

Common accessories

Accessories	Pic	Reference	Specifications	
TUBES¹				
Rilsan PA12 Tube 6/8mm	1	2723	Polyamide/Nylon tube Temperature range: [-40°C ; +80°C]	
Rilsan PA12 Tube 4/6mm	1	2728		
Consolidated Rilsan Tube 4/6mm	2	2746	Consolidated Polyamide/Nylon tube Temperature range: [-40°C ; +70°C]	
Consolidated Rilsan Tube 6/8mm	2	2747		
PFTE TUBE 4/6mm	3	2748	PFTE Tube Temperature range: [-200°C ; +120°C]	
PFTE TUBE 6/8mm	3	2749		
FITTINGS²				
Push-in connections 6/8mm	4	2724	Maximum Temperature: +70°C	
Push-in connections 4/6mm	4	2729		
Elbow fitting 1/8x8	5	2711		
Elbow fitting 1/8x6	5	2712		
Y fitting - Ø6	6	2744		
Y fitting - Ø8	6	2745		
Olive fitting G1/8 - Ø6	7	2765	Maximum Temperature: +180°C	
Olive fitting G1/8 - Ø8	7	2766		
Olive fitting G1/4 - Ø6	7	2767		
Olive fitting G1/4 - Ø8	7	2768		
Olive elbow fitting G1/8 - Ø6	8	2769		
Olive elbow fitting G1/8 - Ø8	8	2772		
Olive elbow fitting G1/4 - Ø6	8	2773		
Olive elbow fitting G1/4 - Ø8	8	2775		
ADAPTORS AND CONNECTORS				
Adaptor M-F M6x100 - G1/8 ²	9	2732		Maximum Temperature: +180°C
Adaptor M-F M8x100 - G1/8 ²	9	2733		
Adaptor M-F M10x100 - G1/8 ²	9	2735		
Adaptor M-F M10x125 - G1/8 ²	9	2736		
Adaptor M-F M10x150 - G1/8 ²	9	2737		
Adaptor M-F M12x125 - G1/8 ²	9	2738		
Adaptor M-F M12x150 - G1/8 ²	9	2739		
Pinion Felt	10	on demand	Ideal to lubricate racks and chains	
Silent Block M6	11	3053	Mitigate vibrations to protect Memolub	
TOM				
TOM 500ml	12	2990	Oil reservoir 500ml	
TOM 1000ml	12	2991	Oil reservoir 1000ml	

¹ sold by 100m

² sold by 10 pieces

MEMOLUB® Services

Memolub® Consulting

We are pleased to provide both invaluable advices and adapted lubrication solutions for your company

AUDIT

- Lubrication audit
- Recommendations

MEMOLUB TOOLS

- Standard lubrication equipment
- Specific lubrication equipment

MEMOLUB SYSTEMS

- HPS lubrication systems
- DS lubrication systems

Memolub® Trainings



We offer workshops and technical trainings at Memolub International HQ or at your premises

- New products and accessories
- Main sectors and applications
- Installation demonstrations
- Market insights and analysis
- Sales & Marketing tools

Memolub® LubeControl

Memolub® Lube Control is a lubrication management software designed to efficiently assist maintenance departments

- Manual lubrication follow-up
- Memolub systems management
- Lubrication calendar exportation
- Data sharing between colleagues



Available upon request

For additional information : contact@memolub.be



www.memolub.com



