

WLS28-2CW570DSQ

Work Light – Linear Light

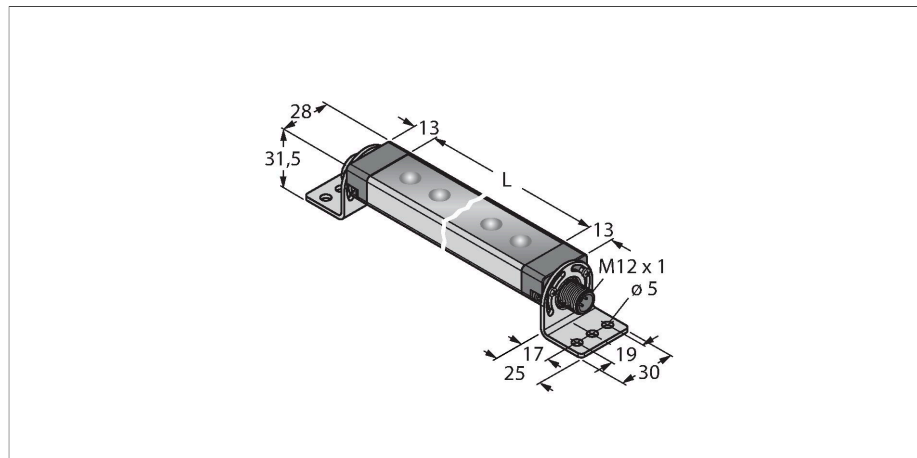

Features

- Cascadable
- Light beam: 570mm
- Operating voltage: 12...30 VDC
- Protection class: IP67 / IP69K
- Color: White
- M12 x 1 male, straight, 4-pin
- SMBWLS28RA mounting bracket included in delivery

Wiring diagram

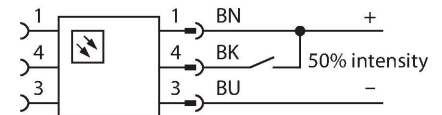

Technical data

Type	WLS28-2CW570DSQ
ID	3087909
Signal and display data	
Purpose	LED work light
Function	Linear light
Light type	White
Color temperature	6100...+7000 K
Luminous flux lumen	975 lm
Aperture angle degree	60 °
Beam angle	wide beam 40-80°
LED service life (L70)	50000 h
Dimmable	Two-stage
Features of color 1	White, Permanently on, 1200 lm
Special features	Wash down
Electrical data	
Operating voltage	12...30 VDC
DC rated operational current	≤ 1360 mA
Input power	16.32 W
Mechanical data	
Cascadable	Yes
Design	Rectangular, WLS28-2
Dimensions	616 x 28 x 20.9 mm
Housing material	Metal, AL
Window material	Polycarbonate, diffuse
Electrical connection	Connector, M12 × 1, PVC
Number of cores	4

Functional principle

The low-energy LED work lights are ideally suited for industrial applications. The color temperature is between 6,000 and 7,100 Kelvin (cool white). Depending on the model, the luminous flux is 325 or 2600 lumen. Some work lights are switched on/off via supply power (10...30 VDC) and some types by means of a button directly at the LED lamp. In addition, the LED can be dimmed to 50% of its light output by activating a high signal on PIN 4, or for the variants with a switch, by means of a further switch position. On some models the light output is continuously dimmable via a PWM signal on pin 4. Cascadable variants are also available. Variants with a clear or diffuse plastic windows, as well as with an aperture angle of 25°.

Application note:

Cascading with 12 V supply allows total light length of 1.4 m. Cascading with 24 V supply allows total light length of 3.0 m. Cascading with 30 V supply allows total light length of 3.1 m.

At 50% light intensity, the length specifications should be doubled.

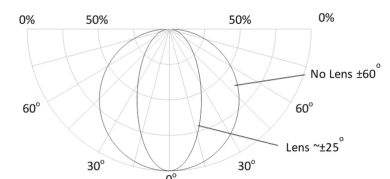

Technical data

Ambient temperature	-40...+70 °C
Storage temperature	-40...+70 °C
Relative humidity	0...90 %
Protection class	IP65 IP67 IP69
Tests/approvals	
Approvals	CE, UL

Accessories

SMBWLSMAG 3019574

Magnetic mounting bracket for mounting on metallic surfaces, for mounting WLS28 work lights

SMBWLS28RA 3015764

Mounting bracket, angled, metal, for WLS28 work lights, 5 mm drill holes, screw set included

SMBWLS28SP 3088063

Snap bracket for mounting WLS28 work lights

Accessories

Dimension drawing	Type	ID	
	RKC4.4T-2/TEL	6625013	Connection cable, female M12, straight, 4-pin, cable length: 2 m, sheath material: PVC, black; cULus approval; other cable lengths and qualities available, see www.turck.com
	WKC4.4T-2/TEL	6625025	Connection cable, female M12, angled, 4-pin, cable length: 2 m, sheath material: PVC, black; cULus approval; other cable lengths and qualities available, see www.turck.com