

► Hybrid stepper motors

6600-30



ROBUSTNESS



HIGH PROTECTION DEGREES



ACCURACY

- Step angle..... 1.8°
- Size 57.2 mm
- Weight 950 g
- Holding torque ... 1950/1400 mNm

The hybrid stepper motor comes into its own where torque at low speed, positioning, and accuracy are determining factors.

► Technical data

	Part N°	Phase resistance [Ω]	Phase inductance [mH]	Phase current [A]	Holding torque [mNm]	Nominal power [W]
Bipolar	6600-30-2-0.37 6600R045	0.37	1.5	4.7	1950	16.5
	6600-30-2-2.6 6600R046	2.6	9	1.8	1950	16.5
Unipolar	6600-20-4-0.37 6600R047	0.37	0.6	4.7	1400	16.5

Steps/rev.	200
Step accuracy	± 5%
Rotor inertia	425 gcm ²
Insulation class	B 130 °C
Protection	DIN 40050 IP 30
Test voltage	500 VAC
Detent torque	70 mNm

► Dimensions

Drawing not to scale. All dimensions in mm.

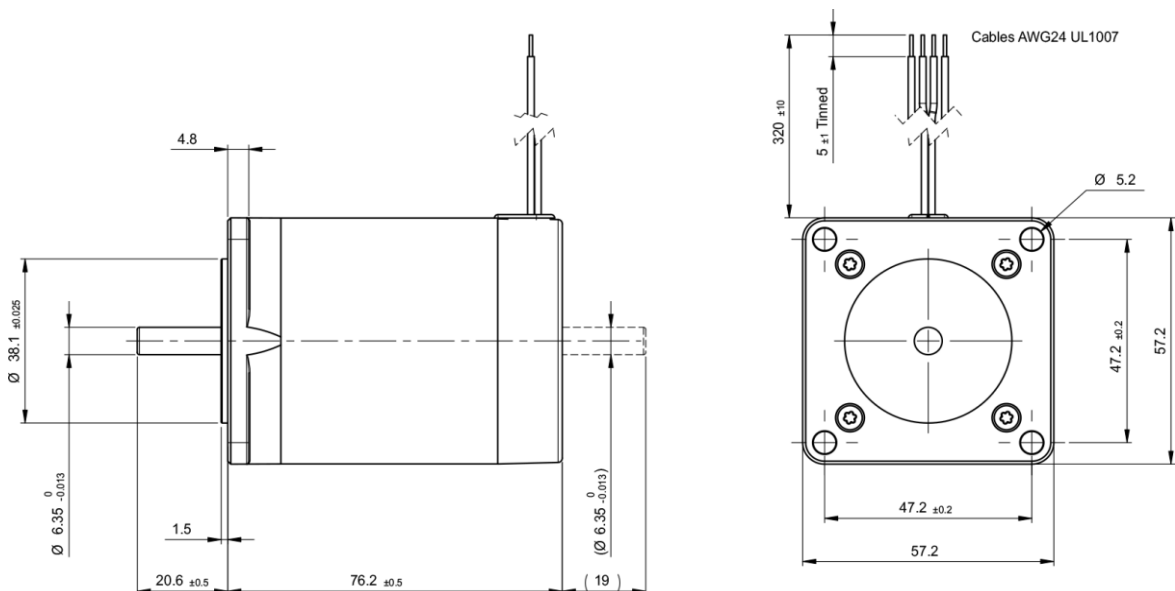

► Dynamic characteristics

• 6600-30-2-0.37

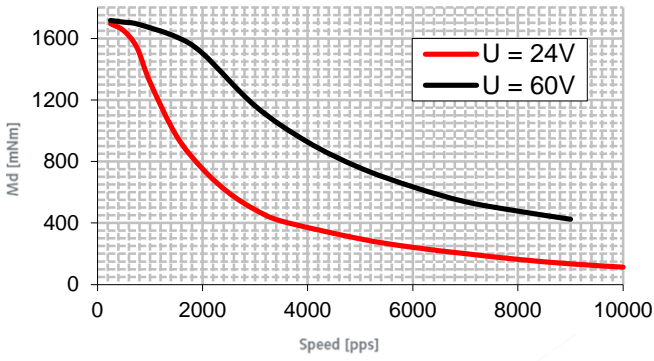

• 6600-30-2-2.6

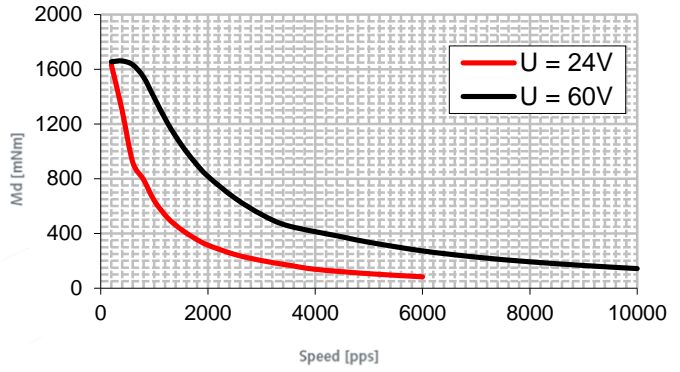

• 6600-30-4-0.37

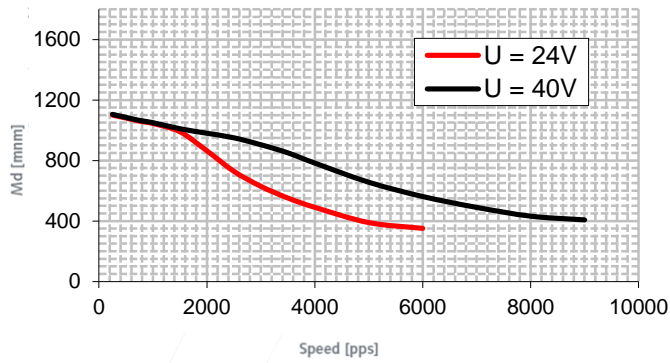

• 6600-30-4-2.6

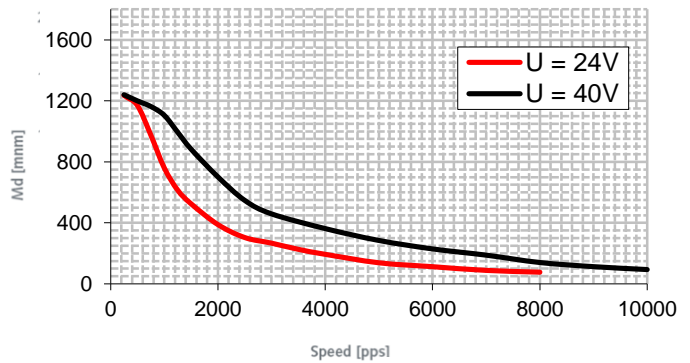

[pps] = pulses per second

► Static characteristics

• 6600-30-2 Series

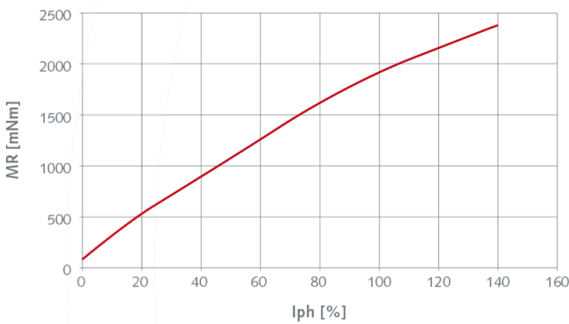

• 6600-30-4 Series

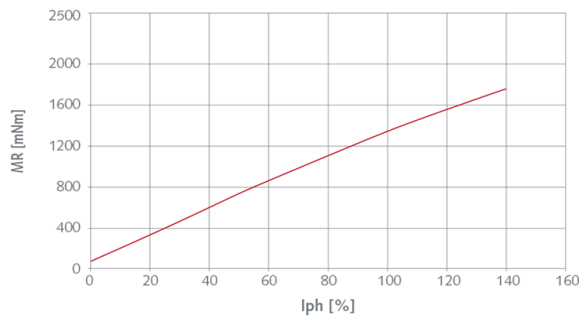

► Electrical Interface

• Bipolar

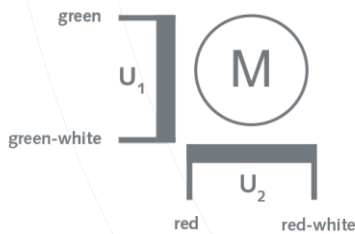

• Unipolar

